



ADL3000-E-B

Installation and operation instruction V1.0

ACREL Co.,Ltd

Declare

The copyright is the property of Acrel. Any information in any paragraph or section cannot be extracted, copied or otherwise reproduced or propagated. Otherwise offenders shall take all consequences.

All rights are reserved.

Acrel reserves the right to modify the product specifications herein without notification. Please consult the local agent about the latest specifications before placing a purchase order.

Content

1	General	1
2	Type description	1
3	Function description	1
4	Technical parameter	2
5	Outline	2
6	Wiring and installing	3
7	Function description	8
8	Operation and display	8
9	Communication description	10

1 General

ADL3000-E-B is a smart meter designed for power supply system, industrial and mining enterprises and utilities to calculate the electricity consumption and manage the electric demand. It features the high precision, small size and simple installation. It integrates the measurement of all electrical parameters with the comprehensive electricity metering and management provides various data on previous 12 months, checks the 31st harmonic content and the total harmonic content, realizes the remote communication and the remote control with switching input . It is fitted with RS485 communication port and adapted to MODBUS-RTU. ADL3000-E-A can be used in all kinds of control systems, SCADA systems and energy management systems. All meters meet the related technical requirements of electricity power meter in the IEC62052-11 、 IEC62053-22 standards.

2 Type description

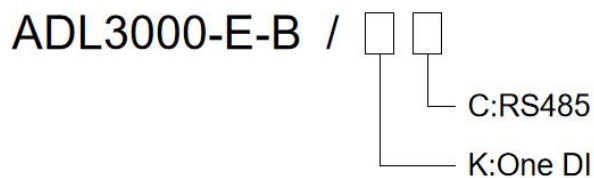

3 Function description

Function	Function description	Function provide
Measurement of kWh	Active kWh (positive and negative)	■
	Reactive kWh (positive and negative)	■
	A, B, C phase positive active kWh	■
Measurement of electrical parameters	U、IP、Q、S、PF、F	■
		■
Measurement of	2~31 ST Voltage and current harmonic	<input type="checkbox"/> Note 1
LCD Display	8 bits section LCD display, background light	■
Key programming	4 keys to communication and set parameters	■
Pulse output	Active pulse output	■
	Reactive pulse output	<input type="checkbox"/>
	Clock pulse output	<input type="checkbox"/>
Functions	Active switch input	<input type="checkbox"/>
Communication	Infrared communication	■
	The first communication path: Communication interface: RS485, Communication protocol: MODBUS-RTU	<input type="checkbox"/>

“■” means standard, “□” means optional.

Note:

1: Harmonic is a standard while choosing outlay transformer, optional for another situation.

4 Technical parameter

	Specification	3 phase 4 wires, Earthed
Voltage	Reference voltage	3 ~ 66/115V、 3 ~ 220/380V(Two sizes)
	Input voltage tolerance	± 30%
	Consumption	<10VA (Single phase) (Rate current or power for power input <10VA(Single phase))
	Impedance	>2MΩ
	Accuracy class	Error ± 0.2%
Current	Input current	3 ~ 1(6)A Min:0.01A,Standard:1A,Max:6A
	Consumption	<1VA (Single phase rated current)
	Accuracy class	Error ± 0.2%
	Power	Active, reactive, apparent power, error ± 0.5%
	Frequency	45~65Hz, Error ± 0.2%
	Energy	Active energy (Accuracy class:0.5, 1), reactive energy (Accuracy class 2)
	Energy pulse output	1 active optocoupler output, Resistive load (Voltage is not more than 24V, current is not more than 5mA)
	Switching input	1 optocoupler input,Maximum allowed voltage: ~220V, OVC III
	Measurement category	CAT III
	Width of pulse	80±20ms
	Pulse constant	6400imp/kWh
	Interface and communication	RS485: Modbus RTU
	Range of communication address	Modbus RTU:1~ 247;
	Baud rate	1200bps~19200bps
	Working temperature	-25°C~+55°C
	Relative humidity	≤95% (No condensation)
	Altitude	≤ 2000m
	Installation environment	Indoor use
	Pollution degree	Class 2

5 Dimension drawings

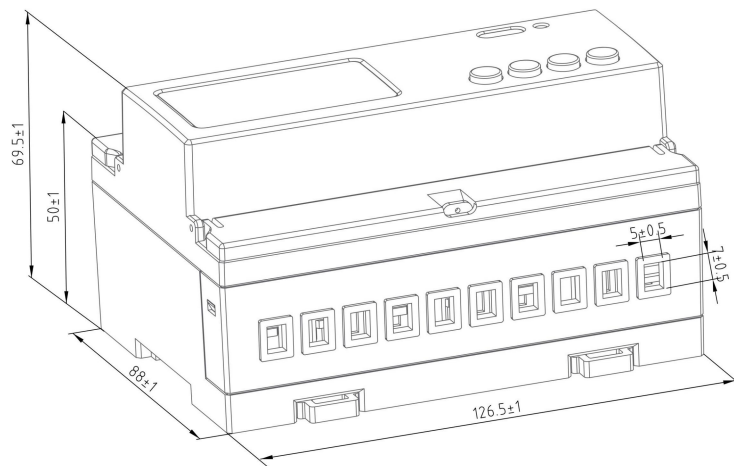

Fig 1 connect via CT

Note : Labels can only be wiped with dry cloth.

6 Wiring and installation

6.1 Safety instruction

Information for your own safety

This manual does not contain all of the safety measures for operation of the equipment (module, device), because special operating conditions, and local code requirements or regulations may necessitate further measures. However, it does contain information which must be read for your personal safety and to avoid material damages. This information is highlighted by a warning triangle and is represented as follows, depending on the degree of potential danger.

The external transformer shall maintain double or enhanced insulation with the current measuring loop of this product



The addition of this symbol to a “Danger” or “Warning” safety label indicates that an electrical hazard exists which will result in personal injury if the instructions are not followed.



L’ apposition de ce symbole sur l’ étiquette de sécurité «danger» ou «avertissement» indique la présence d’ un danger électrique et le non-respect des instructions entraînera des blessures corporelles.



This is the safety alert symbol. It is used to alert you to potential personal injury hazards.

Obey all safety messages that follow this symbol to avoid possible injury or death.



C' est un signe d' avertissement de sécurité. Utilisé pour vous alerter sur les risques potentiels de blessures corporelles. Suivez tous les conseils de sécurité derrière ce signe pour éviter d' éventuelles blessures ou décès.

6.2 Wiring sample of voltage and current

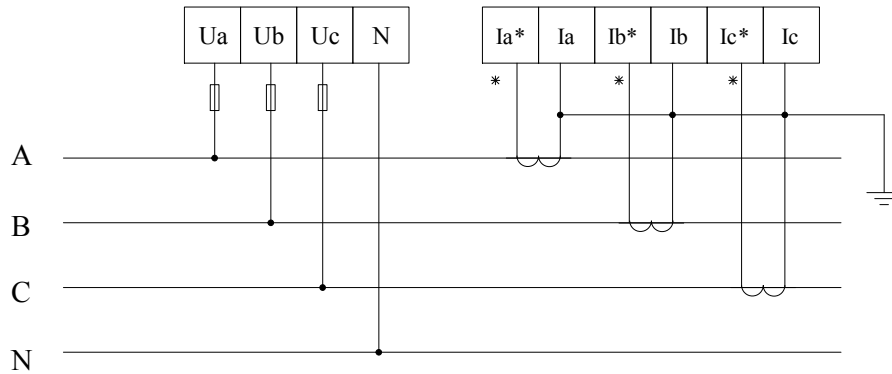
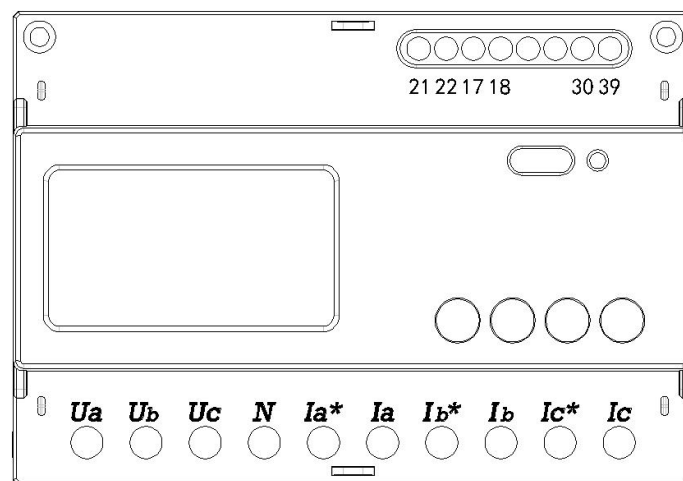

Fig 2 Three phase four lines connect via CT

Note :

1. ADL3000-E-b can adopt one access method: three-phase four wire.
2. One end of the transformer needs to be grounded (Fig2).



product drawing

Port	Description	Remark
Ua	Ua Volatge Input	
Ub	Ub Volatge Input	
Uc	Uc Volatge Input	
N	Neutral Line	
Ia*	Ia Currten Input	
Ia	Ia Currten Output	

Ib*	Ib Currten Input	
Ib	Ib Currten Output	
Ic*	Ic Currten Input	
Ic	Ic Currten Output	

- Recommended cross section: 1...16 mm² (17...5 AWG)
- The necessary torque is 2 N•m (18 lb-in) .

 **WARNING**

- Use copper wire rated for 500V.
- Minimum temperature rating of the cable to be connected to the field wiring terminals, 80 °C.

Failure to follow these instructions can result in death, serious injury, or equipment damage.

 **AVERTISSEMENT**

- Utilisez un fil de cuivre évalué pour 500V.
- Température nominale minimale du câble à connecter aux bornes de câblage sur le terrain, 80 °C.

Le non-respect de ces instructions peut entraîner la mort, des blessures graves ou des dommages à l' équipement.

Port	Description	Remark
21	RS485 port A	
22	RS485 port B	
17	Active pulse output +	
18	Active pulse output -	
30	Digital input	
39	Digital input common	

- Recommended cross section: 0.08...2.5 mm² (30...14 AWG)
- The necessary torque is 0.56 N•m (5 lb-in) .

 **WARNING**

- Use copper wire rated for 500V.
- Minimum temperature rating of the cable to be connected to the field wiring terminals, 80 °C.

Failure to follow these instructions can result in death, serious injury,

or equipment damage.



AVERTISSEMENT

- Utilisez un fil de cuivre évalué pour 500V.
- Température nominale minimale du câble à connecter aux bornes de câblage sur le terrain, 80 ° C.

Le non-respect de ces instructions peut entraîner la mort, des blessures graves ou des dommages à l' équipement.

Installation Requirements

Check that the ambient air temperature and the ambient humidity are within their specified ranges in Environmental Specifications.

Be sure that heat from surrounding equipment does not cause this product to exceed its standard operating temperature.

Din-Rail 35mm mounted device, open type, shall be installed within appropriate enclosures.

Overcurrent protection shall be provided in the end installation.

For use with listed Energy-Monitoring Current Transformers.

Leads of the current transformers shall be maintained within the same end-product enclosure.

The current transformer and its leads shall be segregated from other circuits.

The current transformers are intended for installation within the same enclosure as the equipment. These may not be installed within switchgears and panel boards.



CAUTION

For use with listed Energy-Monitoring Current Transformers.



Remarque

à utiliser avec les transformateurs de courant de surveillance d' énergie énumérés.

Disclaimer

If the equipment is not used in the manner specified by the manufacturer, the protection provided by the equipment may be weakened.

6.3 Communication,Switch input

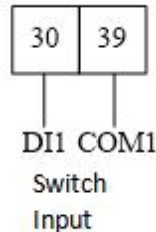
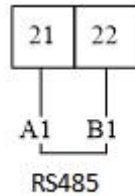

Fig 4 Communication, Switch input

The switch input adapts the method of on-off signal input and powered by outer power supply. It can be gotten by meter when there is a change of on or off via a switching input module. The parameter of switching input can not only get and show the state of local switching information but also achieve the communication via RS485, which called “remote information” function.

7 Maintenance

Replacing the Battery

When the system date or time display is abnormal, it indicates that a battery in the controller needs to be replaced, please inform the manufacturer to replace the battery in time.



WARNING

- Replacing the Battery can only be operated by the manufacturer's personnel.

Failure to follow these instructions can result in death, serious injury, or equipment damage.



AVERTISSEMENT

- le remplacement des piles ne peut être effectué que par le personnel du fabricant.

Le non-respect de ces instructions peut entraîner la mort, des blessures graves ou des dommages à l'équipement.

8 Function description

8.1 Measurement

The meter can measure all electrical parameters such as voltage, current, active power, reactive power, apparent power, power factor, frequency, 31st harmonic and total harmonic. The value format of voltage, current, frequency and power are listed as below.

Example: $U = 220.1V$, $f = 49.98Hz$, $I = 1.99A$, $P = 0.439kW$

8.2 Calculating





The meter can calculate the current active energy, forward active energy, reversing active energy, forward reactive energy and reversing reactive energy.

8.3 Switching input and output

The switch input adapts the method of on-off signal input and powered by outer power supply. It can be gotten by meter when there is a change of on or off via a switching input module. The parameter of switching input can not only get and show the state of local switching information but also achieve the communication via RS485, which called “remote information” function.



9 Operation and display

9.1 Key function description

Key symbol	Key name	Function
	Menu	Enter/quit menu
	Voltage and current, up	Check the voltage and current Leftward and change flash in programming menu
	Power, down	Check the power Rightward and change the value on flash
	Energy, enter	Check the energy Enter in programming menu

9.2 Display menu

The meter will show the forward active energy after powering. The customers can change the information showing by pressing the keys. The menu description is listed as below:

	Voltage on A, B, C phase, Current on A, B, C phase, Frequency, Date, Time, Address, Version, Test on display
	Total active/reactive/apparent power and on A, B, C phase, Total power factor and on A, B, C phase, Forward/reversing active/reactive maximum demand
	Total forward/reserving active/reactive energy, forward/reserving active/reactive

	energy, forward active energy on A, B, C phase.
--	---

Note:

1 All the display menus above are in the model of ADL3000-E-B three phases four lines with multi-tariff rate function and can be changed by the keys.

2 There will not be power or power factor on each phase and will only show total power and power factor (Active, reactive, apparent) under the three phase three lines.



Current forward active energy 12.34kWh



Current reversing active energy 12.34kWh



Current forward reactive energy 12.34kWh



Current total power is 1.234kW





Voltage on A phase is 123.4V





Current on A phase is 12.34A

Note: There are parts of the display function, and other menus are familiar with the example above. The customers can understand the meaning refer to the above examples.

9.3 Key Menu

Press  at any main menu and get in "PASS" interface, and then press  show

“0000”, and enter the code. If you enter a wrong code, it will show “fail” and back to main menu; and if you enter a right code, you can set the parameter. After setting the parameter and press , it will show “save” and save the change by pressing  in “yes” interface and quit without save by pressing  in “no” interface.

9.4 Data settings

Num	First menu		Second menu		
	Symbol	Mean	Symbol	Mean	Range
1	BUS	Communication settings	ADDR	Address setting	1-247
			Baud	Baud rate	19200、9600、4800、2400、1200
			Parity	Parity	None、Even
2	SyS	System settings	PL	Network	3P4L: 3 phase 4 lines 3P3L: 3 phase 3 lines
			EF.E	Multi-tariff rate	EF: Multi-tariff rate E: No multi-tariff rate
			Code	Code setting	1-9999
			LED	Time of light	1-9999
3	In.	Transformer settings	Pt	Voltage transformer	1-9999
			Ct	Current transformer	1-9999

Note: Customers can choose None or Even under Modbus protocol.

10 Communication description

The meter adapts MODBUS-RTU protocol, and the baud rate can be chosen from 1200bps、2400 bps、4800 bps、9600bps and 19200 bps. The parity is None.

The meter needs shielded twisted pair conductors to connect. Customers should consider the whole network’s parameters such like communication wire’s length, the direction, communication transformer and network cover range, etc.

Note:

Wiring should follow the wiring requirements;

Connect all the meter in the RS485 network even some do not need to communication, which is benefit for error checking and testing;

Use two color wires in connecting wires and all the A port use the same color.

No longer than 1200 meters of RS485 bus line.

10.1 ADDR list

MODBUS-RTU protocol has 03H and 10H command to read and write registers respectively. The following chart is registers' address list:

Address	Variable	Length	R/W	Notes
0000H	Current total active energy	4	R	$E = \text{data} * \text{PT} * \text{CT} * 0.01$
000AH	Current forward active total energy	4	R	Data: data read in the communication, Pt: voltage ratio CT: current ratio Unit:kWh (active) kVarh(reactive) This formula is applicable to all electric energy values.
0014H	Current reversing active total energy	4	R	
001EH	Current total reactive energy	4	R	
0028H	Current forward reactive total energy	4	R	
0032H	Current reversing reactive total energy	4	R	
003FH high byte	First communication path: Address	1	R/W	
003FH low byte	First communication path: Baud rate	1	R/W	1: 9600pbs 2: 4800pbs 3: 2400pbs 4: 1200pbs
0040H	Pulse constant	2	R	
0061H	Voltage of A phase	2	R	$U = \text{data} * \text{PT} * 0.1$ Unit:V
0062H	Voltage of B phase	2	R	
0063H	Voltage of C phase	2	R	
0064H	Current of A phase	2	R	$I = \text{data} * \text{CT} * 0.01$ Unit:A
0065H	Current of B phase	2	R	
0066H	Current of C phase	2	R	
0067H-0076H	Reserve			
0077H	Frequency	2	R	$F = \text{data} * 0.01$ Unit:Hz

0078H	Voltage between A-B	2	R	U=data*PT*0.1 Unit:V
0079H	Voltage between C-B	2	R	
007AH	Voltage between A-C	2	R	
0087H	Forward active energy of A phase	4	R	
0089H	Forward active energy of B phase	4	R	
008BH	Forward active energy of C phase	4	R	
008DH	Voltage transfer(PT)	2	R/W	
008EH	Current transfer(CT)	2	R/W	
008FH	State of DIDO, over-voltage, loss-voltage	2	R	
0090H	Reserve	2	R	
0091H high byte	Running state 1	1	R/W	
0091H low byte	Running state 2	1	R/W	
0092H	Zero sequence current	2	R	
0093H	Voltage imbalance	2	R	unit 0.1%
0094H	Current imbalance	2	R	
0095H	First communication path: Testing byte (High 8 bytes) Stop byte (Low 8 bytes)	2	R/W	testing byte: 0: none 2: even stop byte: 0: 1 stop byte 1: 2 stop bytes
0096H- 0163H	Reserved			
0164H	Active power of A phase	4	R	
0166H	Active power of B phase	4	R	

0168H	Active power of C phase	4	R	PQS=data*PT*CT*0.001 Unit:KW(active) kVar(reactive) kVA(apparent) Active power and reactive power are signed data, please set them as signed variables.
016AH	Total active power	4	R	
016CH	Reactive power of A phase	4	R	
016EH	Reactive power of B phase	4	R	
0170H	Reactive power of C phase	4	R	
0172H	Total reactive power	4	R	
0174H	Apparent power of A phase	4	R	
0176H	Apparent power of b phase	4	R	
0178H	Apparent power of c phase	4	R	
017AH	Total apparent power	4	R	
017CH	Power factor of A phase	2	R	PF=data*0.001 Data is signed data, please set them as signed variables.
017DH	Power factor of B phase	2	R	
017EH	Power factor of C phase	2	R	
017FH	Total power factor	2	R	

10.2 Sub harmonic data

ADL3000-E-B has function of harmonic. The function include 31st harmonic statistics of voltage and current, harmonic voltage and current of each phase apparently, harmonic active/reactive power of each phase apparently, fundamental voltage and current of each phase apparently and fundamental active/reactive power of each phase apparently.

Addr	Name	Length	R/W	Note
05DDH	THDUa	2	R	Total distortion rate of voltage and current on each phase Int Keep 3 decimal places
05DEH	THDUb	2	R	
05DFH	THDUc	2	R	
05E0H	THDIa	2	R	
05E1H	THDIb	2	R	
05E2H	THDIc	2	R	
05E3H	THUa	2 × 30		Harmonic voltage on

0601H	THU _b	2 × 30		2 nd -31 st
061FH	THU _c	2 × 30		Int Keep 3 decimal places
063DH	THI _a	2 × 30		Harmonic current on 2 nd -31 st
065BH	THI _b	2 × 30		
0679H	THI _c	2 × 30		
0697H	Fundamental voltage on A phase	2		Int Keep 1 decimal places
0698H	Fundamental voltage on B phase	2		
0699H	Fundamental voltage on C phase	2		
069AH	Harmonic voltage on A phase	2		
069BH	Harmonic voltage on B phase	2		
069CH	Harmonic voltage on C phase	2		
069DH	Fundamental current on A phase	2		Int Keep 2 decimal places
069EH	Fundamental current on B phase	2		
069FH	Fundamental current on C phase	2		
06A0H	Harmonic current on A phase	2		
06A1H	Harmonic current on B phase	2		
06A2H	Harmonic current on C phase	2		
06A3H	Fundamental active power on A phase	2		Int Keep 3 decimal places
06A4H	Fundamental active power on B phase	2		
06A5H	Fundamental active power on C phase	2		
06A6H	Total fundamental active power	2		
06A7H	Fundamental reactive power on A phase	2		
06A8H	Fundamental reactive power on B phase	2		
06A9H	Fundamental reactive power on C phase	2		
06AAH	Total fundamental reactive power	2		
06ABH	Harmonic active power on A phase	2		
06ACH	Harmonic active power on B phase	2		
06ADH	Harmonic active power on C phase	2		
06AEH	Total harmonic active power	2		
06AFH	Harmonic reactive power on A phase	2		
06B0H	Harmonic reactive power on B phase	2		
06B1H	Harmonic reactive power on C phase	2		

06B2H	Total harmonic reactive power	2		
-------	-------------------------------	---	--	--