

PZ Series programmable intelligent meters

Three phase electrical
(E3/E4)

Installation and Operation Instruction V1.9

ACREL Co., Ltd.

DECLARATION

No part of this publication may be reproduced, stored in a retrieval system, or transmitted in any form by any means, electronic, mechanical photocopying, recording, or otherwise without prior permission of Acrel. All rights reserved.

This company reserve power of revision of product specification described in this manual, without notice. Before ordering, please consult local agent for the latest specification of product.

CONTENTS

1.General.....	- 1 -
2 Type and specification of products.....	- 1 -
3. Technical parameters.....	- 1 -
4.Installation guide.....	- 2 -
4.1 Outline and mounting cutout size.....	- 2 -
4.2 installation method.....	- 2 -
4.3 Terminal arrangement and connection.....	- 3 -
5. Program and usage.....	- 4 -
5.1Measurement items and faceplate.....	- 4 -
5.2 Key and specified function.....	- 4 -
5.3Programming menu.....	- 6 -
5.4 Programming Example.....	- 7 -
5.5 Programming flow chart.....	- 9 -
6.Communication guide.....	- 11 -
6.1 General.....	- 11 -
6.2 Protocol.....	- 11 -
6.3 Error check method.....	- 12 -
6.4Communication parameter address table	- 12 -
6.5 Communication application.....	- 14 -
6.6 Connection mode in communication.....	- 18 -

1. General

PZ Series electric energy meters, adopting AC sampling technology, can measure many three phase grid electrical parameters such as current, voltage, power, electric energy etc. directly or indirectly. It may be used for local display, and connected with the control equipment to form measuring and controlling system.

Fitted with RS-485 communication port, adopting compatible Modbus-RTU protocol, meters can switch electric parameter signal into standard analog output, with four-channel (two-channel) switching input / two-channel switching output. Based on different requirements, by keys on the faceplate, electric parameters for transformation ratio, alarm, communication etc. can be set up and controlled.

PZ series meters have extra high price performance ratio, can simply replace traditional electric transducer and measuring meters. As an advanced intelligent, digital front end acquisition component, this electric meters have widely used in various control system, SCADA system and energy source management system.

2 Type and specification of products

Meter type	Basic function	Shape	Optional function
PZ72-E4/* PZ72L-E4/*	EPI/EPE, active power, reactive power, power factor measurement; Three phase current, voltage, frequency measurement		1. 2 channel transmitting output+1 pulse+RS485 communication(/MC) 2. 2DI2DO+1 pulse+RS485 communication(/KC)
PZ80-E3/* PZ80-E4/*	EPI/EPE, EQL/EQC measurement; Active power, reactive power, power factor measurement;		1. Switching 4DI+1 pulse+RS485 communication(/KC) 2. 1 channel transmitting output+2 pulse+RS485 communication (/MC) 3. Maximum demand record(/MD)
PZ80L-E3/* PZ80L-E4/*	Three phase current, voltage measurement		
PZ96-E3/* PZ96-E4/*	EPI/EPE, EQL/EQC measurement; Active power, reactive power, power factor measurement; Three phase current, voltage, frequency measurement		1. Switching 4DI+1 pulse+RS485 communication(/KC) 2. Switching 2DI2DO+RS485 communication(/KC) 3. Switching 4DI+RS485 communication(/KC) 4. 2 channel transmitting output+2 pulse+RS485 communication(/MC) 5. Maximum demand record(/MD)
PZ96L-E3/* PZ96L-E4/*			
PZ42-E3/* PZ42-E4/	EPI/EPE, EQL/EQC measurement; Active power, reactive power, power factor measurement; Three phase current, voltage, frequency measurement		1. Switching 8DI2DO+RS485 communication(/KC) 2. Switching 8DI+ 2 pulse+RS485 communication(/MC) 3. 2 channel transmitting output+ 2 pulse+RS485 communication(/MC)
PZ42L-E3/* PZ42L-E4/*			

Explain : 1. Meter without additional functionality, with two-way power pulse output, optional digital input/output case, there was no power pulse.

2. Only meters with LCD have function of /MD.

3. Technical parameters

Technical parameters		Value
input	Connection	3-phase-3-wire, 3-phase-4-wire
	frequency	45-65HZ
	voltage	rating: AC 100V、400V
		overload: 1.2 fold rating {continuous} : 2 fold rating for 1 second

		power consumption : < 0.2VA
	current	Rating: AC IA、 5A
		overload: 1.2 fold rating (continuous) ; 10fold rating for 1 second
		power consumption : < 0.2VA
output	electric energy	Output mode: 2 channel open-collector photo coupler pulse pulse constant: 10000 , 40000, 160000 imp/kWh
	communication	RS485port, Modbus -RTU protocol
	display	LED or LCD display, set multiplying power, alarm, switching indication at will;For 1 channel analog, display related programmable setting
function	Switching input	2channel or 4channel passive dry contact input mode
	Switching output	Output mode: 2 channel relay NO contact output
		contact capacity- 1A/30VDC 1A/250VAC
Analog output	Output mode: 1, 2 or 4 channel Output, 0 - 20mA, 4 - 20mA programmable	
	load capacity≤500Ω	
accuracy class		Frequency 0.05Hz, reactive electric energy 1 class, others 0.5class
power supply		DC100~350V;AV 85~265V; (In order to instrument wiring shall prevail)
Security		power consumption<5VA
Equipment withstand voltage= power supply, voltage input circuit 2kVAC; power supply,current circuit 2.5kV/1min(RMS) Insulation resistance- input, output end to housing >100MΩ		

Environment	Temperature	work: -10°C~+55°C storage: -25°C ~+75°C	
	Humidity	≤93%RH Non-condensing	
	Altitude	≤2500m	

4.Installation guide

4.1 Outline and mounting cutout size

Outline unit : mm	faceplate size		housing size			cutout size	
	width	height	width	height	depth	width	height
72 square	75	75	66	66	98	67	67
80 square	84	84	75	75	98	76	76
96 square	96	96	86	86	92	88	88
42 square	120	120	106	106	92	108	108

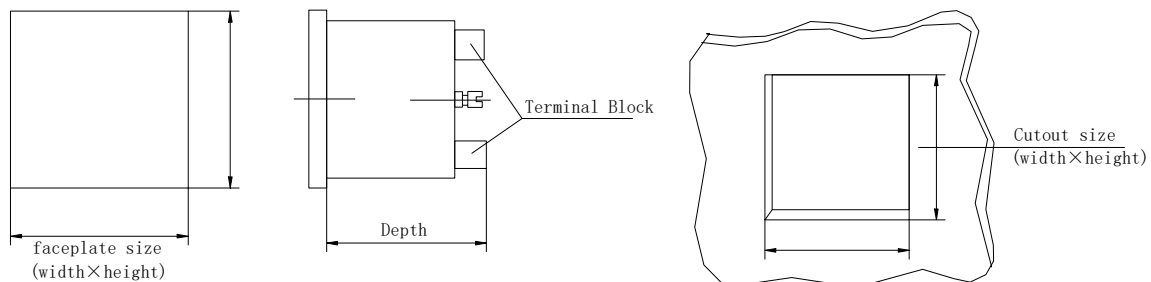

4.2 installation method

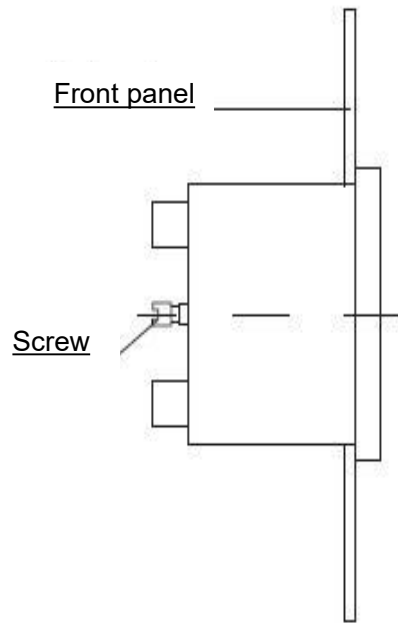
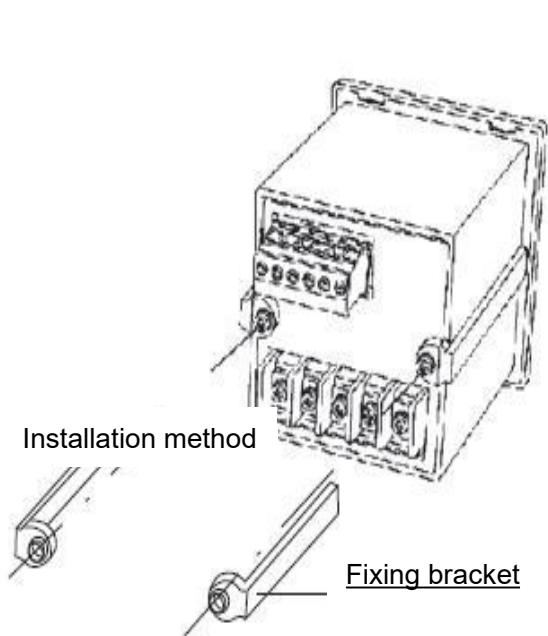

4.3 Terminal arrangement and connection (Note: taking the diagram on the housing as standard)

4.3.1 Voltage, current signal terminal

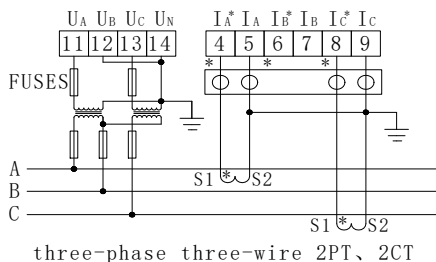
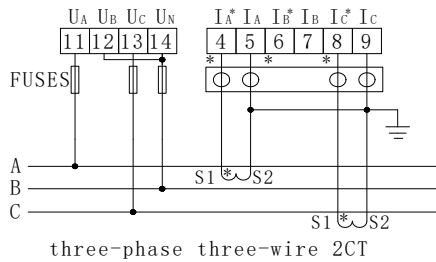
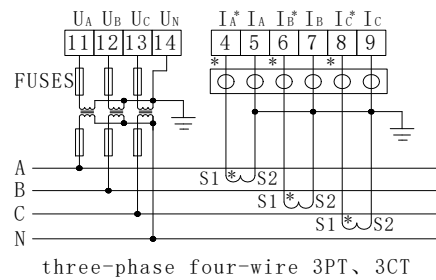
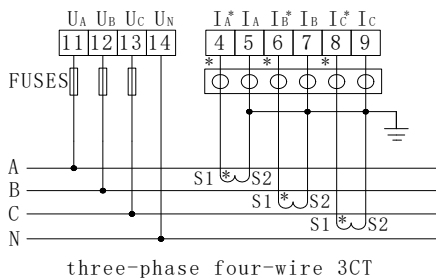

Note: For Three-phase-three-wire, No. 12 terminal must be connected with No.14 terminal

4.3.2 Switching input/output terminal

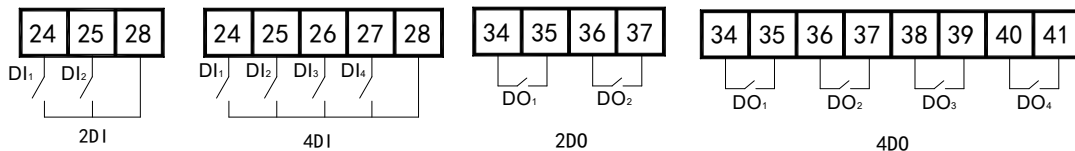

Switch input adopt wet contact switch signal input mode, with built-in +5V operational power supply, the meter need not external power supply. When the external is in ON or OFF, the ON or OFF information is collected by the input module of meter switch and is displaying locally, and implement remote transmission function, i.e. "remote signaling" function by meter digital port RS485.

The switching output adopt relay output, implement "telecontrol" function by remote control of the supervisory computer, and implement corresponding alarm function by user's request.

4.3.3 Power supply terminal, RS485communication terminal、 pulse output terminal.

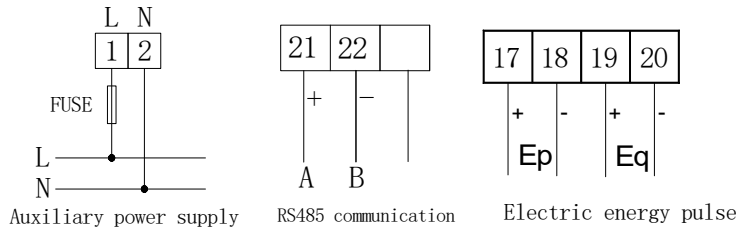

4.3.4 Analog output terminal

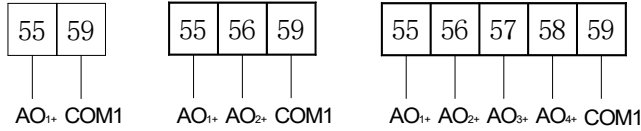

5. Program and usage

5.1 Measurement items and faceplate

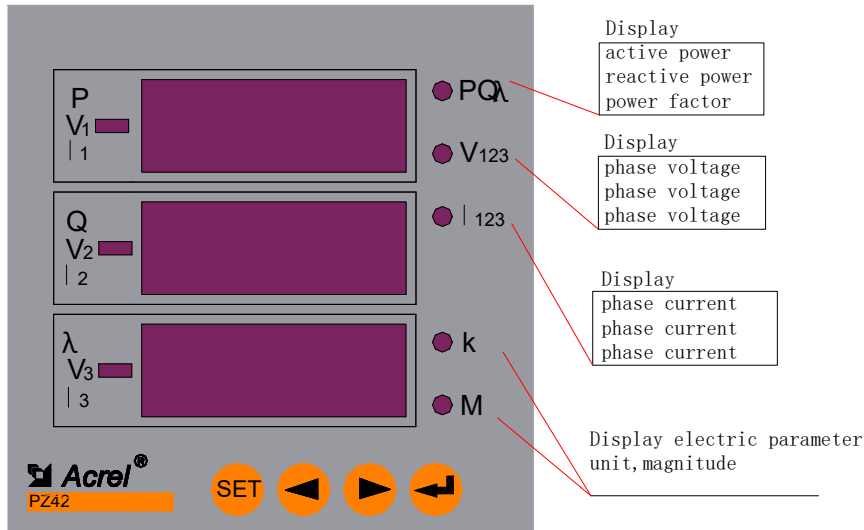

In the right indicators, if only kor M lights, and Level 1 number code display: EPI、EPE、EqL or EqC, then Level 2, Level 3 display :electric energy data: Level 2 is high bits, Level 3 is low bits; if Level 1 display EPI, Level 2 display 0011, Level 3 display 01.58, k indicator lights, other indicators never illuminate, then active electric energy is used (Power Consumption): 1101.58 kWh.

PZ Series electric energy meters may measure four-quadrant electric energy data: EPI - absorption active electric energy, EPE- release active electric energy, inductive reactive electric energy, EqC-capacitive reactive electric energy₀

Digital display meter, electric energy display data as primary side data; liquid crystal display as secondary side data.

Note: Left P1 Q, A and other characters show: When the right indicator lights, this level digital displays electric parameter kind; left "minus sign" not ON commonly, if connection is improper, split-phase active power P may display as negative value, this may be used for connection checking.

5.2 Key and specified function.



SET Key



Left key



Right key



Enter key

SET Key	measure mode DOWN, press SET Key enter program mode, meter Prompt input password PASS, after input correct password, put meter in programming;
---------	--

	program mode DOWN, used for Return to previous menu.
Left key	measure mode DOWN, press Left key display three phase voltage; program mode DOWN, used for page Up of same level menu or decrease 1 in ones place.
Right key	measure mode DOWN, press Right key display three phase current; program mode DOWN, used for page Down of same level menu or increase 1 in ones place.
Enter key	E3(E4) : press Enter key, cycling check each quadrant electric energy etc. program mode DOWN, affirming the selection of menu and revision of parameters.
Left key +Enter key	program mode DOWN, used for decrease 1 in hundreds place.
Right key +Enter key	Program mode DOWN, used for increase 1 in hundreds place.

5.2.1 Digital (LED) display :E3/E4 electric parameters checking flow chart

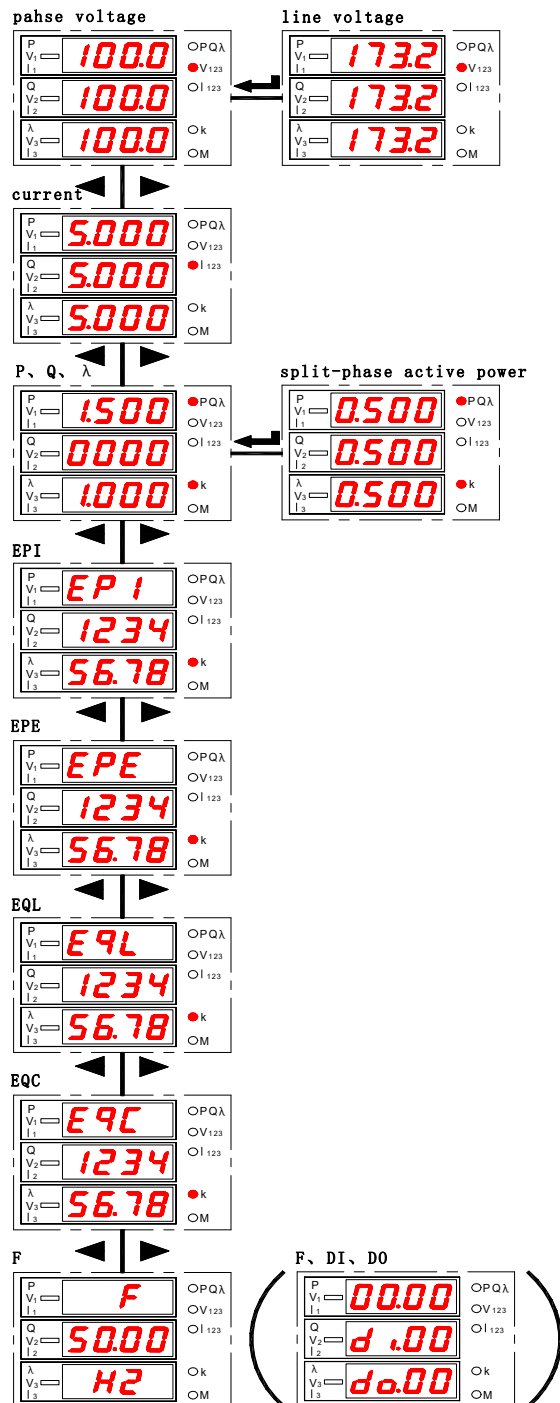

3-phase-4-wire power meter, electric energy meter, electric parameter checking flow chart(LED).

Explanation

1.The electric parameter in the dotted line block is indicated in the electric energy meter (E3/E4);

2.3-phase-3-wire meter, press the left shift key, only showing line voltage; other electric parameter checking flow chart is same as the 3-phase-4-wire case;

3.When the power meter check other electric parameters, after 10s or so, returning to power display interface;

4. After electric energy meter checked other electric parameter, fixing display the latest checked electric parameter picture, press ENTER to return electric energy picture.

5.2.2 Liquid crystal (LCD) display: E3/E4 electric parameters checking flow chart

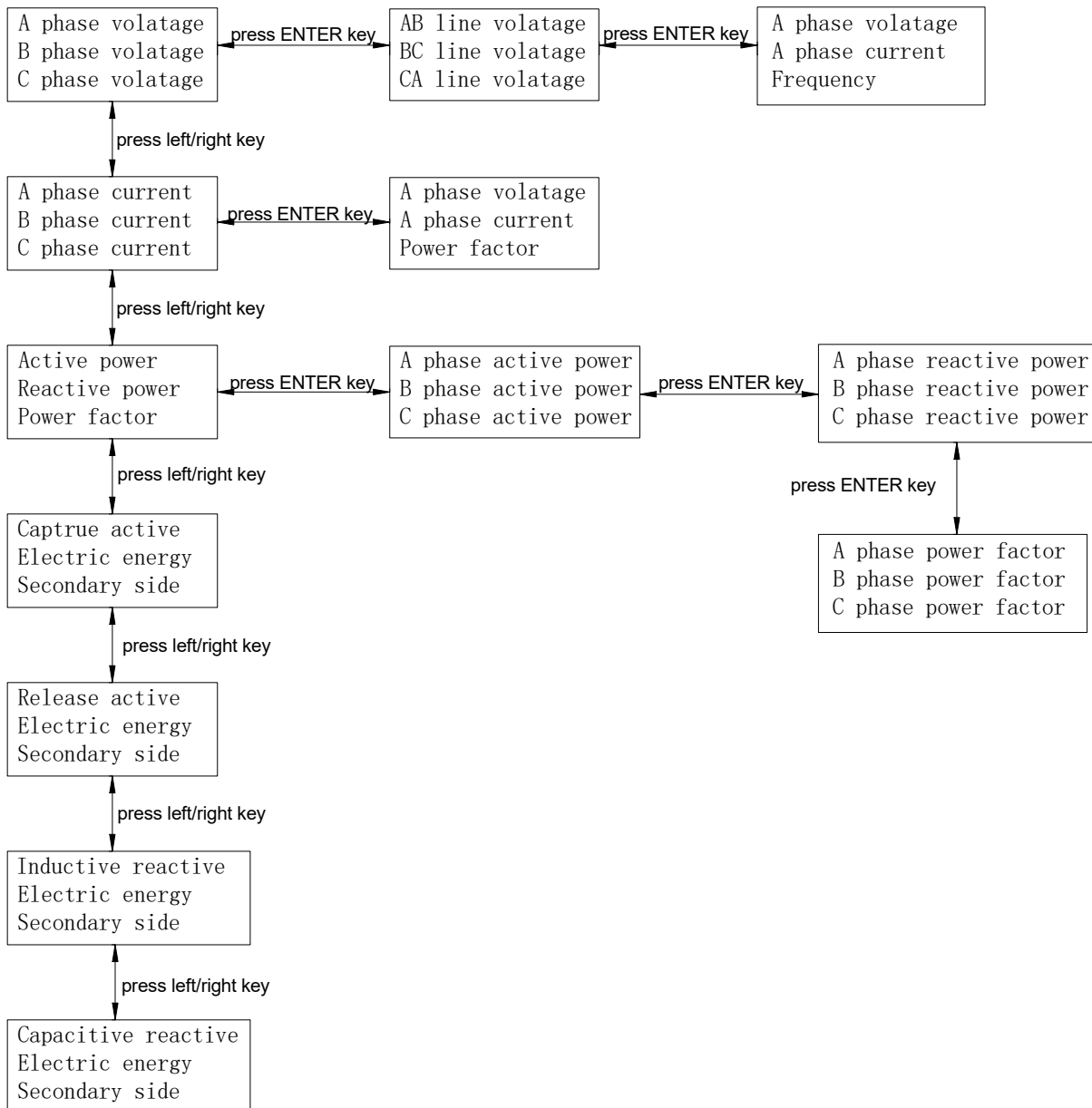

5.3 Programming menu

5.3.1 Meter general programming menu

Level 1 menu	Level 2 menu	Level 3 menu	Explanation
Sys	diSP	1-6	Starting display menu selection
	CodE	0001 -9999	Password setting(initial password 0001)
	Clr.E		Press Enter key, electric energy zero

			clearing
	CLr. d		Press Enter key, clear demand record
	EP. Eq	E1/E2	Primary(E1) or secondary(E2) energy display option
	PLUS		Constant of Energy plus
In	LinE	3P3L 、 3P4L	Input network (3-phase-3-wire, 3-phase-4-wire)
	In.U	100、 400	Input voltage range
	In.I	1、 5	Input current range
	In.Pt	1 -9999	Input voltage transformation ratio
	In.Ct	1-9999	Input current transformation ratio
buS	Addr	1-247	communication address
	bAUd	4800、 9600 19200、 38400	communication baud rate
	ModE	None/2bit/odd/even	Communication data mode
tr.1-tr 4	001-026 101-126	0-9999	First channel transmitting (analog output) for detail, see 5.4.4 Fourth channel transmitting(analog output)

5.3.2 Added LCD display meter back light control menu

Level 1 menu	Level 2 menu	Level 3 menu	Explanation
SyS	b.Lcd	0-255	Setting as 0, backlight lights; Setting as 1 ~ 255, after 1 ~ 255 sec. backlight is extinguished.

5.3.3 Added menu with switching output

PZ meter 's switching output adopt relay output, there are two controlling modes for relay:

1.electrical level mode (relay NO or NC);

2.pulse mode(after closing specified time, the relay is breaking, the closing specified time is controlled by PL.do)

5.4 Programming Example

Programming Example take flow chart form to introduce changing some items in the Programming menu ,such as current transformation ratio, transmitting setting etc..

Note: After setting or selecting: press Enter key to affirm confirm ,after affirming completion, continuously press SET KEY until SAVE/YES page appearing ,press Enter key to affirm ,otherwise, the setting is invalidation

5.4.1How to entry into Programming menu.

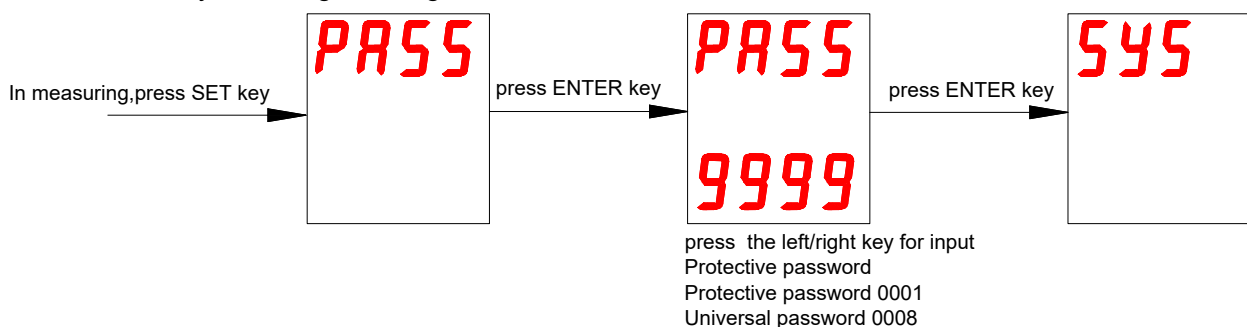

5.4.2 How to revise current transformation ratio

After entry into Programming menu, as per following flow chart, to entry into current transformation ratio setting menu.

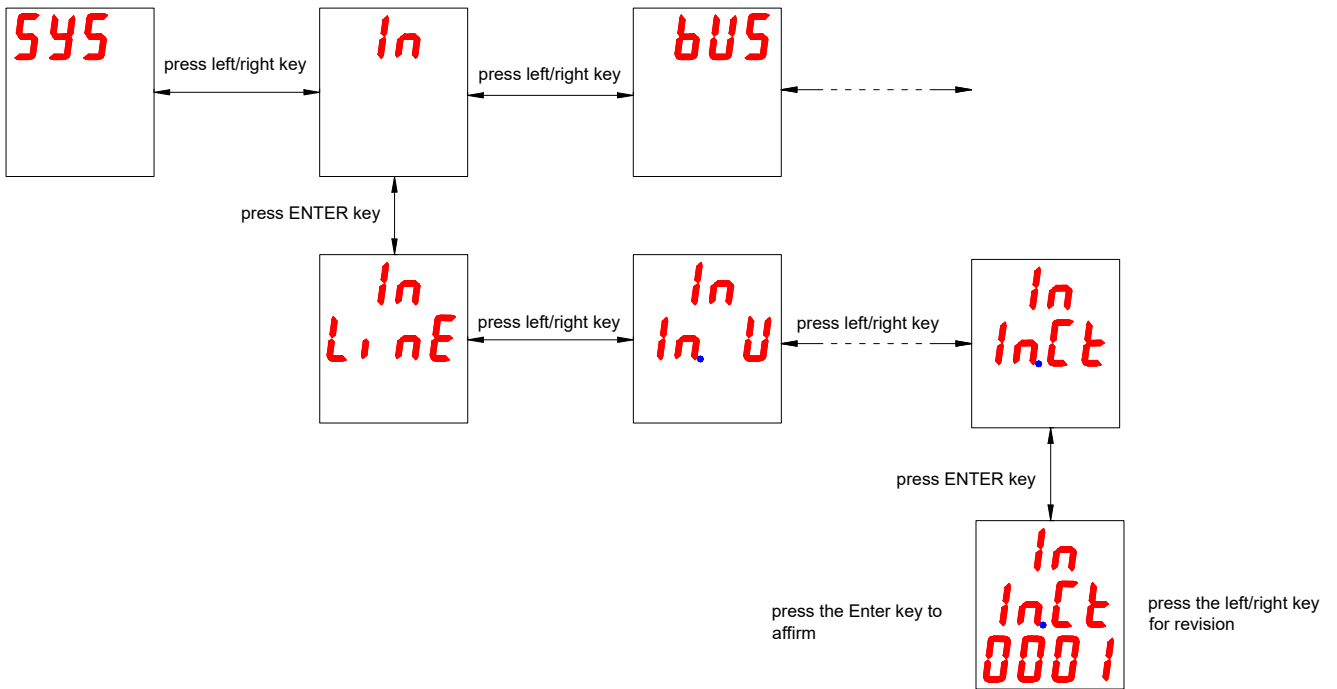

Note: The voltage transformation ratio (In.Pt) setting is similar. Other parameters in this menu need not revision usually.

5.4.3 How to revise communication parameters

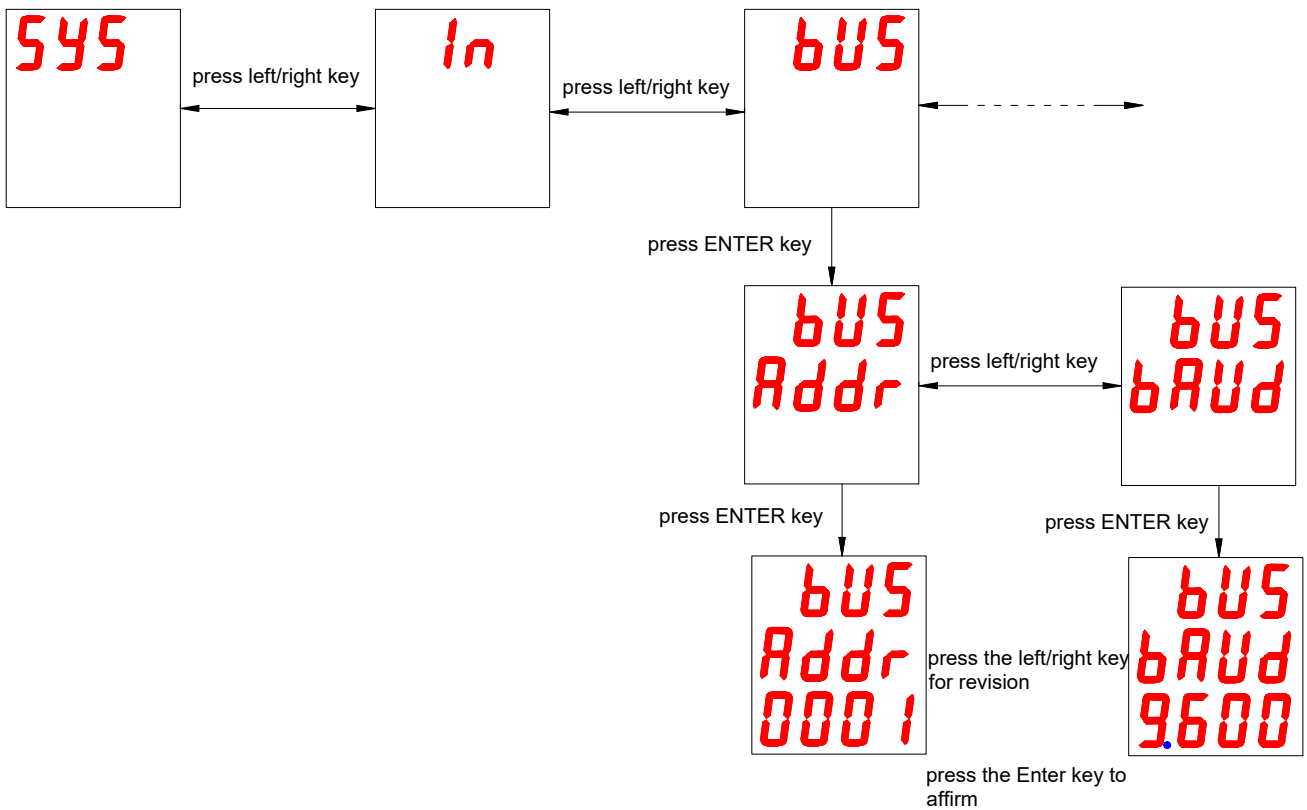

5.4.4 How to revise transmitting setting

Simulate transmitting output can be done by isolating two of 26 electric parameters commonly appearing in grid(Ua, Ub, Uc, Uab, Ubc, Uca, Ia, Ib, Ic, Pa, Pb, Pc, P total, Qa, Qb, Qc, Qtotal, PFa, PFb, PFc, PF, Sa, Sb, Sc, S total, F) and transmitting output of DC signal of 0~20mA or 4~20.

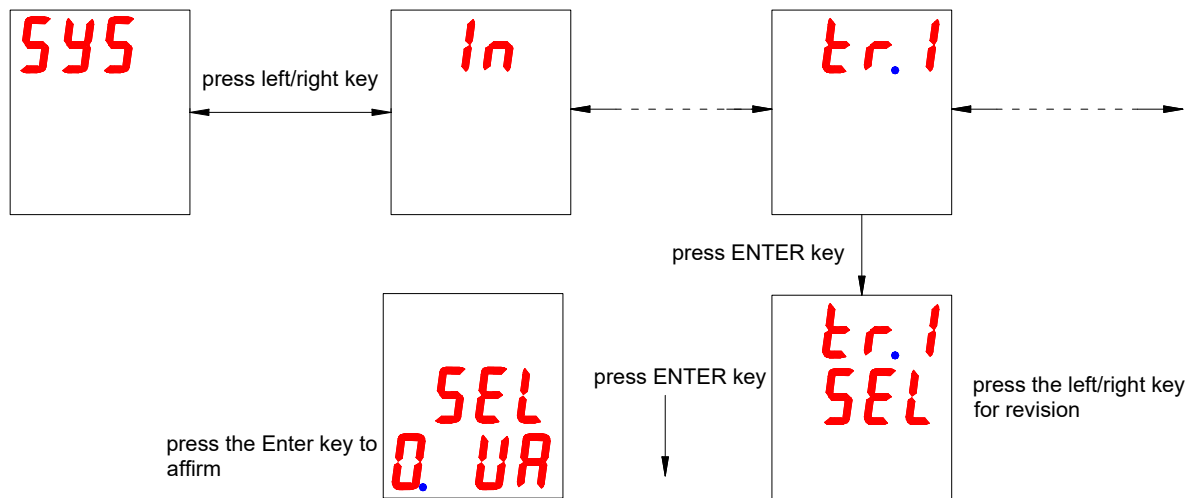

Explanation:

SEL	00	01	02	03	04	05	06	07	08	09	10	11	12
	UA	UB	UC	UAB	UBC	UCA	IA	IB	IC	PA	PB	PC	P总
	13	14	15	16	17	18	19	20	21	22	23	24	25
	QA	QB	QC	Q总	SA	SB	SC	S总	PFA	PFB	PFC	PF	F
TYPE	4~20mA or 0~20mA output type												
AOH1	20mA output is corresponding with electric parameter display value:if input is 220V,100A/5A,3-phase 4-wire,then 100% P total is $220V \times 100A \times 3 = 66kW$, display value is 66.00kW , and this value take 66.00. For 3-phase 3-wire,then $220V \times 100A \times \sqrt{3} = 38.10kW$,take 38.10; analog output setting of other electric parameters is similar;												
AOLO	4mA(0mA)output corresponding with parameter display value												

5.4.5 How to save setting parameters

After revising the specified parameters, press the Enter key to affirm, then press SET key to return, until the right interface is appearing; at this interface press the Enter key to save, press the SET KEY to quit

5.5 Programming flow chart(basic function, excluding the additional functions, refer to 5.4 programming example)

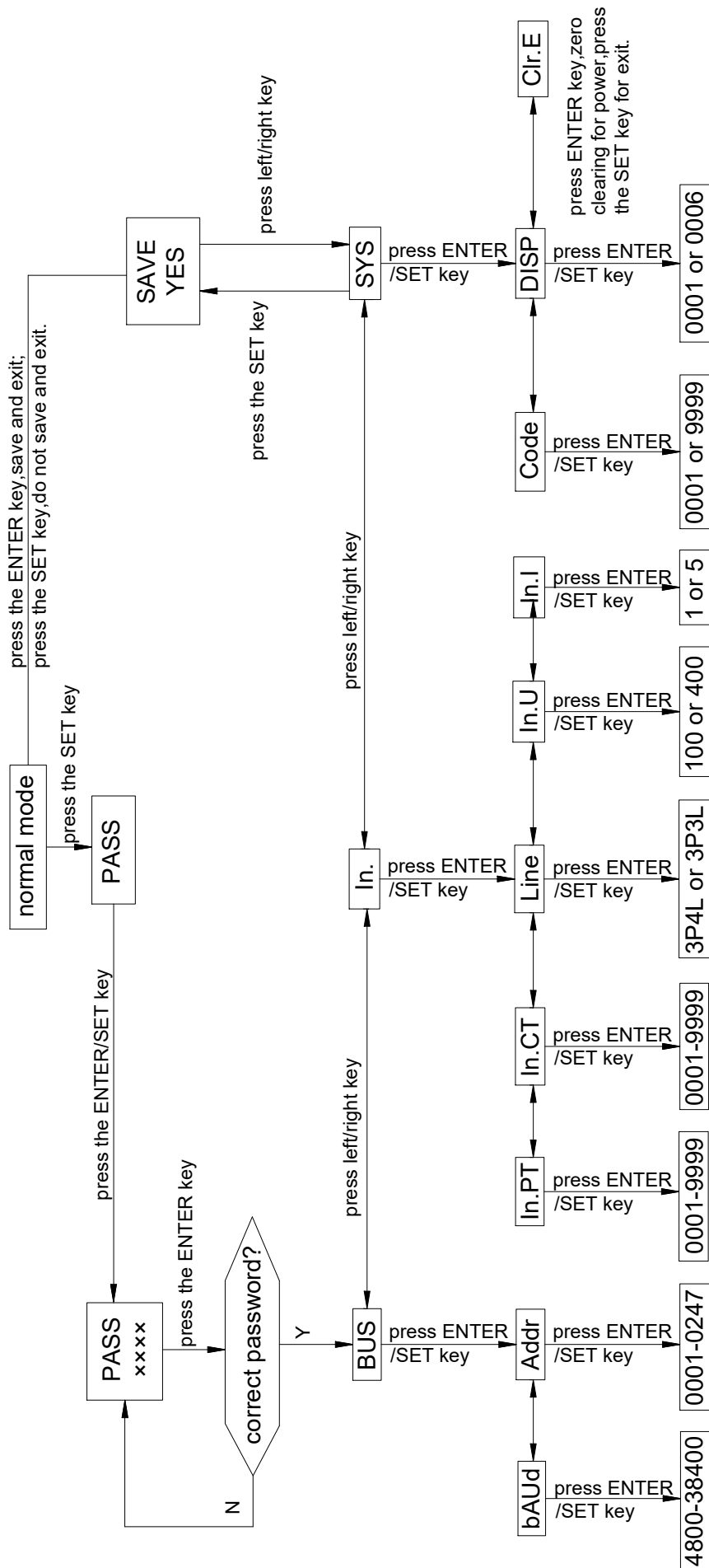

6.Communication guide

6.1 General

PZ Series meters adopt protocol compatible with Modbus-RTU: “9600,8,n,1” ,in it 9600 as default baud rate, it may be revised as 4800, 19200 38400 etc. via Programming, if needed , the setting method refer to this instruction 5.4.3 communication parameter setting; 8 indicate 8 data bit; n indicate non-parity check bit; 1 indicate 1 stop bit.

Error detection : CRC16 (cyclic redundancy check)

6.2 Protocol

When Data frame reach terminal unit, it through a simple “port”, entry of the addressed unit, this unit take out Data frame "envelope" (data head), read data, if there is no error, execute job requested by data, then, adding self-produced data to the acquired “envelope ”, and return Data frame back to the sender. The returned responding data include following content: the terminal slave machine address (Address), the executed command(Function), the requested data resulting from command executing (Data)and one CRC check code (Check) . Any error never lead to successful responding, or return one error indicating frame.

6.2.1 Data frame format

Address	Function	Data	Check
8-Bits	8-Bits	N x 8-Bits	16-Bits

6.2.2 Address domain

The address domain is at the front of the frame, composed of one byte (8-Bits, 8 bit binary code), decimal scale is 0 ~ 255, in our system, only 1 ~ 247 is used, other address is reserved .these bits indicate the terminal unit address specified by users, this unit will accept host computer data connected with it. Every terminal unit address in the same FieldBus must be one and only, only the addressed terminal can respond the query including this address. When the terminal is sending one responding , the slave machine address data in this responding can tell host computer which terminal unit is communicating with it.

6.2.3Function domain

The function domain code tells the addressed terminal which function shall be executed .The function code and its meaning and function in this Series meters are listed below.

Code (hexadecimal system)	Meaning	conduct
03H	Read register keeping	Acquire current binary value from one or multiple register keeping
04H	Read input register	Acquire current binary value from one or multiple input register
10H	Setting multiple register	Load concrete binary value into string continuous register keeping

6.2.4 Data domain

The data domain includes: the needed data for terminal to execute specified function or the collected data when terminal respond the query. These data may be value, parameter address or setting. Example: function domain tell terminal unit to read one register, data domain must specify: The reading is starting from which register and how many data is needed . For the embedded address and data, the content depends on the different type and different slave machine.

6.2.5Error check domain

This domain adopts CRC16 cyclic redundancy check, the data transmission checking function error

of host computer and terminal is allowable. Because of electrical noise and other interfere, sometimes, when one group data is transmitting from one unit to another unit, in the data transmission process, there may be some changes, the error check can ensure master machine or slave machine not respond those changed data, so, the security, reliability and efficiency of system are upgraded

6.3 Error check method

The error check (CRC) domain occupy two bytes, including one 16 bit binary value. CRC value is calculated by the transmission unit, then adding to Data frame, during accepting data , the accept unit is recalculating the CRC value, then comparing with the accepted value in CRC domain, if these two values is not equal, the error occurs.

When calculating CRC, at first, setting one 16 bit register as whole-1 ,then continuously calculating the 8 bit of each byte in Data frame with current value of this register, only 8 data bit of each byte is taking part in producing CRC. the starting bit and the stop bit and the possible parity bit have no influence to CRC. When producing CRC, 8 bit of each byte with content of register to do exclusive or, then shift the result to the low bit, the high bit is complementarity with "0", Least Significant Bit (LSB) is shifted and detected, if it is 1 ,this register carry out one exclusive or operation with one preset fixed value(0A001H), if the Least Significant Bit is 0, there is not any treatment.

Flow of CRC forming:

- 1.Preset one 16 bit register as OFFFHH (whole-1), called as CRC register •
- 2.Carrying out exclusive or operation between 8 bit of the first byte in the Data frame and the lower byte in the CRC register, to save the result back to CRC register.
- 3.Right shift CRC register for one bit, the highest bit filling 0.the Least Significant Bit is shifted and detected.
- 4.If the Least Significant Bit is shifted and as 0: repeat the third step(next shift); if the Least Significant Bit is shifted and as 1 !Carrying out exclusive or operation between CRC register with one preset fixed value (0A001H).
- 5.Repeat the third step and the fourth step, until 8 shift. So, one integrated 8 bit is treated.
6. Repeat the second step to the fifth step to treat next 8 bit, until all the byte treatment are completed.

The final CRC register value is the CRC value.

Another CRC calculation method is the look-up table technique with feature of fast calculating speed, but need

larger save space, please refer to related data.

6.4Communication parameter address table (word) for electric energy meter

Address	Parameter	R/W	Value range	Data type
0000H	Password saved	R/W	0001-9999	word
0001H High byte	Communication address	R/W	0001-0247	word
0001H Low byte	Communication baud rate	R/W	0-3: 38400、 19200s、 9600、 4800bps	
0002H	Control character	R/W	8th bit-connection mode (0-3-phase-4-we, 1-3-phase-3-wire) 7th bit-input voltage range (0-400V, 1-100V) second bit-input current range (0-5A, 0-1 A)	word
0003H	PT transformation	R/W	1-9999	word

	ratio			
0004H	CT transformation ratio	R/W	1-9999	word
0005H - 000AH	tr.1-tr.4 4-channel transmitting parameter	R/W	Each channel occupy 3 byte	word
000BH -0021H	Reserved			
0022H	Switching Input output state	R/W	For detail, see next page attached table	word
0023H 0023H High byte	Decimal point U(DPT)	R	3-7	word
0023H 0023H Lower byte	Decimal point I(DCT)	R	1-5	
0024H High byte	Decimal point PQ(DPQ)	R	4-10	word
0024H Lower byte	Symbol PQ	R	High bit-low bit:Q, Qc, Qb, Qa, P, Pc, Pb, Pa;0= positive, 1= negative	
0025H	Phase voltage Ua	R	0-9999(Conversion formula based on 6.5.1)	word
0026H	Phase voltage Ub	R	0-9999(Same as above)	word
0027H	Phase voltage Uc	R	0-9999(Same as above)	word
0028H	Line voltage Uab	R	0-9999(Same as above)	word
0029H	Line voltage Ubc	R	0-9999(Same as above)	word
002AH	Line voltage Uca	R	0-9999(Same as above)	word
002BH	Ia	R	0-9999(Same as above)	word
002CH	Ib	R	0-9999(Same as above)	word
002DH	Ic	R	0-9999(Same as above)	word
002EH	Pa	R	0-9999(Same as above)	word
002FH	Pb	R	0-9999(Same as above)	word
0030H	Pc	R	0-9999(Same as above)	word
0031H	P total	R	0-9999(Same as above)	word
0032H	Qa	R	0-9999(Same as above)	word
0033H	Qb	R	0-9999(Same as above)	word
0034H	Qc	R	0-9999(Same as above)	word
0035H	Q 总 Q total	R	0-9999(Same as above)	word
0036H	PFa	R	0-1000(Same as above)	word
0037H	PFb	R	0-1000(Same as above)	word
0038H	PFc	R	0-1000(Same as above)	word
0039H	PF total	R	0-1000(Same as above)	word
003AH	Sa	R	0-9999(Same as above)	word
003BH	Sb	R	0-9999(Same as above)	word
003CH	Sc	R	0-9999(Same as above)	word
003DH	S total	R	0-9999(Same as above)	word
003EH	Frequency FR	R	4500-6500(Same as above)	word

003FH - 0040H	absorptive active electric energy secondary side	R/W	0-999999999(Same as above)	Long
0041H - 0042H	Release active electric energy secondary side	R/W	0-999999999(Same as above)	Long
0043H - 0044H	Inductive reactive electric energy secondary side	R/W	0-999999999(Same as above)	Long
0045H - 0046H	CAPACITIVE REACTIVE ELECTRIC ENERGY SECONDARY SIDE	R/W	0-999999999(Same as above)	Long
0047H - 0048H	absorptive active electric energy primary side	R	(Same as above)	Float
0049H - 004AH	Release active electric energy primary side	R	(Same as above)	Float
004BH - 004CH	Inductive reactive electric energy primary side	R	(Same as above)	Float
004DH - 004EH	Capacitive reactive electric energy primary side	R	(Same as above)	Float
004FH	Maximum demand	R	0-9999	word
0050H ~ 0051H	Maximum demand time	R	Month,day,hour,minute	Long

Switching input/output state (0022H)

1.PZ72(L)、PZ80(L)、PZ96(L)

0022H	16	15	14	13	12	11	10	9	8~1
			D02	D01	DI4	DI3	DI2	DM	Reserved

2、PZ42(L):

0022H	16	15	14	13	12	11	10	9	8~1
	DM	DI2	DI3	DI4	D01	D02	D03	D04	Reserved

6.5 Communication application

6.5.1 Reading data

The measuring value of this series is read out by 03H Command of Modbus-RTU communication protocol,

the relation between the communication value and the actual value is shown as following : (Default Val_t= communication reading, Val_s= actual value)

Applied parameter	Relation	Unit
-------------------	----------	------

Voltage value UA、 UB、 UC	Val_s = (Val_t /10000) * (10^DPT)	V
Current value IA、 IB、 IC	Val_s = (Val_t/10000) * (10^DCT)	A
value PA、 PB、 PC、 P 总、 QA、 QB、 QC、 Q 总	Val_s = (Val_t /10000) * (10^DPQ)	W 、 var
POWER FACTOR value PFA、 PFB、 PFC、 PFS	VALS = VALT/1000	NONDIMENSIONAL
Frequency FR	Val_s = Val_t /100	Hz
Secondary side value	Val_s = Val_t	Wh、 varh

Electric energy primary side measuring value adopts the floating point variable data mode. It use Symbol bit to indicate symbol of number, use biased exponent and mantissa to indicate size of number. The data format of meter is IEEE754 data format with 24 bit precision, the high bit of mantissa is always "1", Non-Save, distribution of bits is shown as following :

1 bit= symbol bit,8 bit= exponent bit,23 bit= mantissa, the symbol bit is the highest bit, the mantissa is the lowest 23 bit.

The actual example is shown below:

Reading number: 0 10001110 100 1011 1010 1100 0000 0000b

Symbol bit S=0₁ ("1" = negative, "0" = positive); Computing exponent E=10001110, changing into decimal number 142;

Computing mantissa M=100 1011 1010 1100 0000 0000, changing into decimal number 4959232。

\Computing formula:Primary side electric power consumption

$$(-1)^S \times 2^{(E-127)} \times \left(1 + \frac{M}{2^{23}}\right)$$

Calculated result:

$$(-1)^0 \times 2^{(142 - 127)} \times \left(1 + \frac{4959232}{2^{23}}\right) = 52140Wh = 52140Wh$$

6.5.2Write (data)

For this series, using 10H command of Modbus-RTU communication protocol to write, such as switching output control

Query Data frame	01 10 00 22 00 01 02 10 00 ad 12 (DO1 output) 01 10 00 22 00 01 02 20 00 b9 12 (DO2 output) 01 10 00 22 00 01 02 30 00 b4 d2 (DO1、 DO2 output)
Return Data frame	01 10 00 22 00 01 a1 c3
Explanation:For switching output status bit, remote write 1, then closing; write 0, then breaking.	

645 protocol address table					
Label coding	Data format	Byte	Unit	Read and write	Data item name
00000000	XXXXXX.XX	4	kWh	R	(present) combination active total electric energy
00010000	XXXXXX.XX	4	kWh	R	(present) forward active

					total electric energy
00010100	XXXXXX.XX	4	kWh	R	(present) forward active rate 1 electric energy
00010200	XXXXXX.XX	4	kWh	R	(present) forward active rate 2 electric energy
00010300	XXXXXX.XX	4	kWh	R	(present) forward active rate 3 electric energy
00010400	XXXXXX.XX	4	kWh	R	(present) forward active rate 4 electric energy
0001FF00	XXXXXX.XX	4×5	kWh	R	(present) forward active electric energy data block
00020000	XXXXXX.XX	4	kWh	R	(present) reverse active total electric energy
0002FF00	XXXXXX.XX	4×5	kWh	R	(present) reverse active electric energy data block
00030000	XXXXXX.XX	4	kWh	R	(present) combination reactive1 total electric energy
00040000	XXXXXX.XX	4	kWh	R	(present) combination reactive 2 total electric energy
00ff0000	XXXXXX.XX	4×5		R	Quadrant power data
01010000	XX.XXXX YYMMDDhhmm	8	kW year, month, day, hour	R	(present) maximum total positive work demand and its occurrence time
02010100	XXX.X	2	V	R	A phase voltage
02010200	XXX.X	2	V	R	B phase voltage
02010300	XXX.X	2	V	R	C phase voltage
0201FF00	XXX.X	2×3	V	R	Voltage data block
02020100	XXX.XXX	3	A	R	A phase current
02020200	XXX.XXX	3	A	R	B phase current
02020300	XXX.XXX	3	A	R	C phase current
0202FF00	XXX.XXX	2×3	A	R	Current data block
02030000	XX.XXXX	3	kW	R	Total active power
02030100	XX.XXXX	3	kW	R	A active power
02030200	XX.XXXX	3	kW	R	B active power
02030300	XX.XXXX	3	kW	R	C active power
0203FF00	XX.XXXX	4×3	kW	R	active power data block
02040000	XX.XXXX	3	kvar	R	Total reactive power
02040100	XX.XXXX	3	kvar	R	A reactive power
02040200	XX.XXXX	3	kvar	R	B reactive power
02040300	XX.XXXX	3	kvar	R	C reactive power
0204FF00	XX.XXXX	4×3	kW	R	reactive power data block

02050000	XX.XXXX	3	kVA	R	Total apparent power
02050100	XX.XXXX	3	kVA	R	A apparent power
02050200	XX.XXXX	3	kVA	R	B apparent power
02050300	XX.XXXX	3	kVA	R	C apparent power
0205FF00	XX.XXXX	4×3	kW	R	apparent power data block
02060000	X.XXX	2		R	Total power factor
02060100	X.XXX	2		R	A power factor
02060200	X.XXX	2		R	B power factor
02060300	X.XXX	2		R	C power factor
0206FF00	X.XXX	4×2		R	power factor data block
02800002	XX.XX	2	Hz	R	Grid frequency
04000101	YYMMDDWW	4		R/W	Date
04000102	Hhmmss	3		R/W	Time
04000401	XXXXXXXXXX XX	6		R/W	Correspondence address
04000402	XXXXXXXXXX XX	6		R/W	Table number

6.6 Connection mode in communication

Four connection mode in communication section are shown as following:

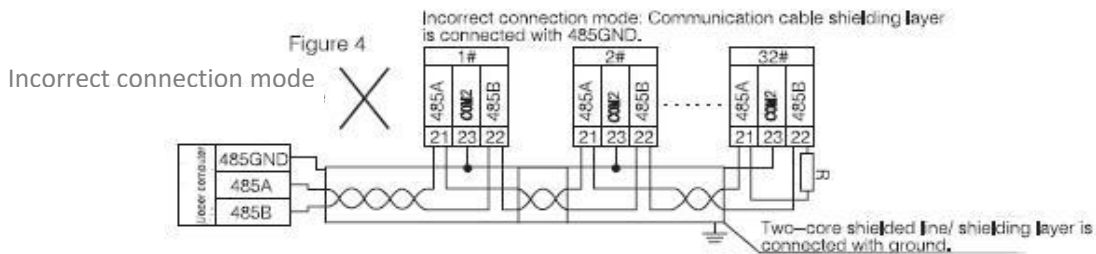
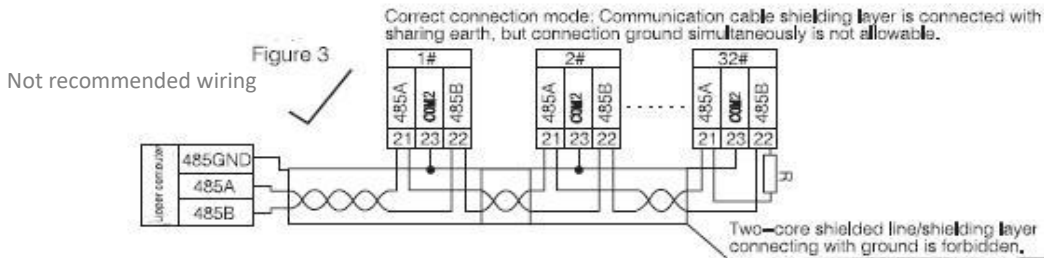
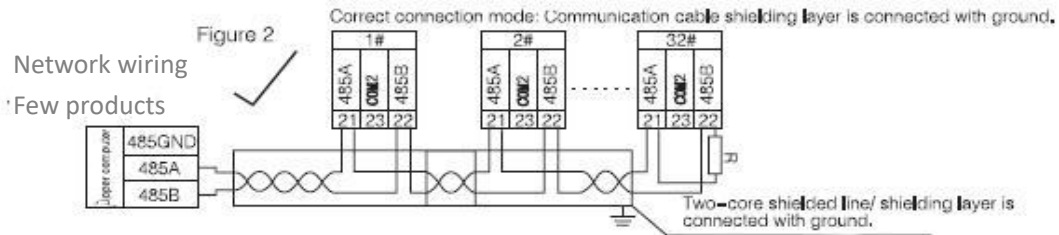
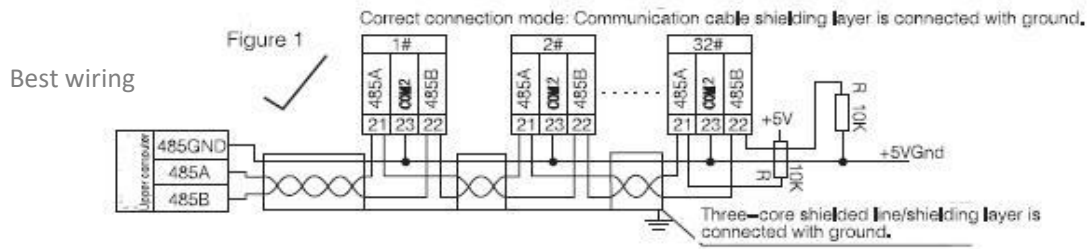

Recommendation of adding matched resistance between A₁ B of the last meter, the rated resistance range is 120Ω~10kΩ.